

Nautica Assembly Instruction Sheet



Please check that all the parts are present before you start
Carefully follow the instructions step by step

Bulb: 60W max energy saving bulb

Care: Remove and wipe clean with damp cloth

Contact: info@kaigami.com

Online construction video: YouTube - Kaigami Nautica

Parts:  x3  x3 Gimble x 6  Rivets x 9 (2 spare)

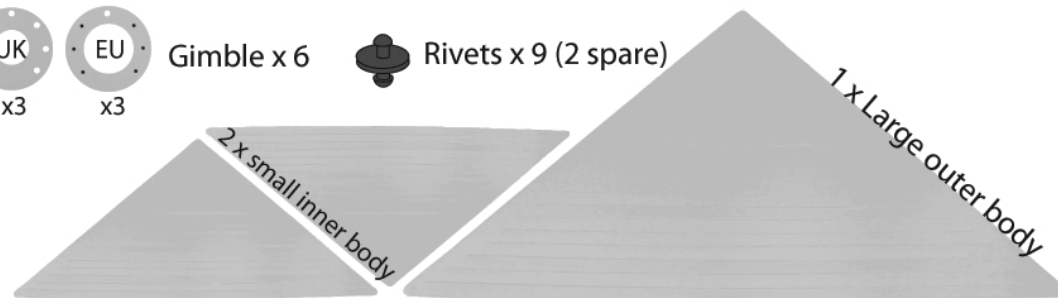

Step 1: Join the two inner bodies together by placing rivets inbetween the parts

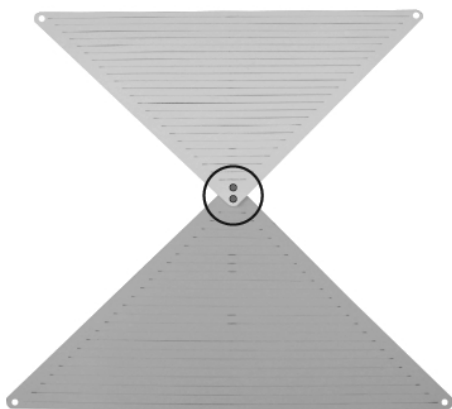

Step 2: Choose which size gimble fits the unscrewed ceiling lamp holder, then attach two gimble together as shown

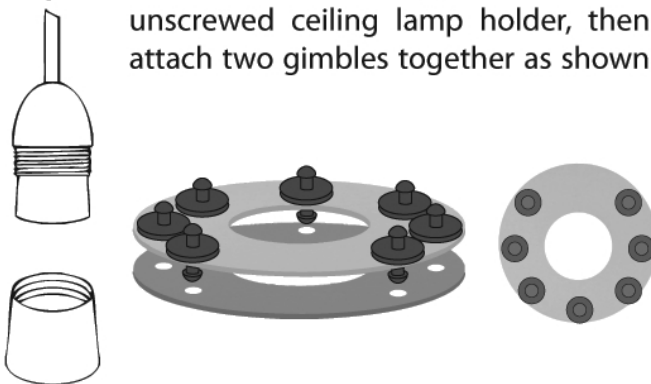

Step 3: Bring the four corners up to the gimble and attach as shown

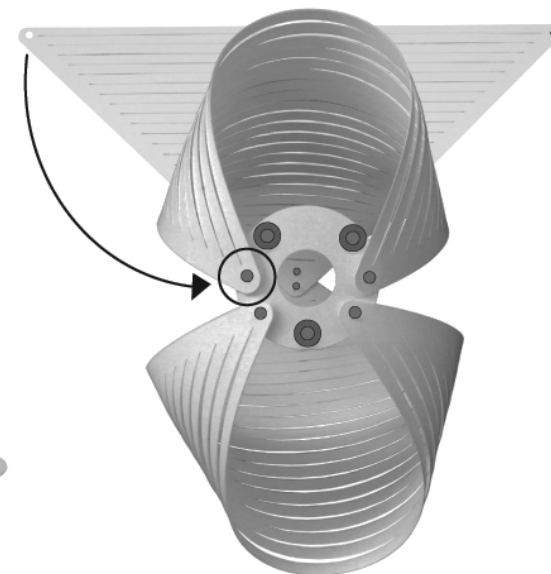

Step 4: Place the large outer body underneath as illustrated

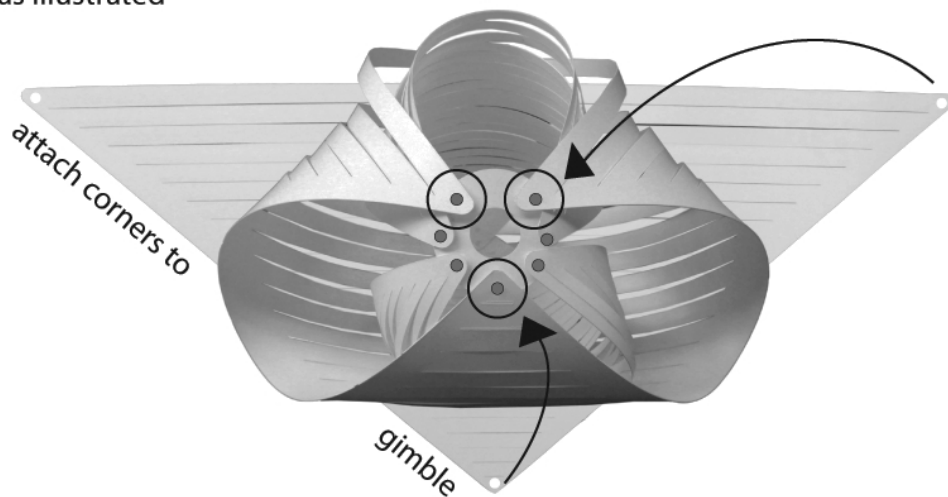

Step 5: Clip final gimble on top to finish shade

